

# Harmonics and Flicker Analysis in Arc Furnace Power Systems

J. Sousa<sup>(\*)</sup> M.T. Correia de Barros M. Covas A. Simões

IST - Technical University of Lisbon  
Instituto da Energia - INTERG  
Av. Rovisco Pais, 1096 Lisboa Codex  
<sup>(\*)</sup> previously at LABLEC / EDP group  
PORTUGAL

**Abstract** - This paper presents guidelines for the accurate evaluation of harmonics and flicker generated by ac electric arc furnaces, and its propagation through transmission and distribution systems. It is presented a typical case where a HV system supplies a high capacity arc furnace. The electrical network is simulated using the ATP version of the EMTP where a non-linear time-varying three-phase arc model is implemented in MODELS. The time-domain simulations are then used to evaluate the harmonic distortion and the short-term flicker severity index ( $P_{st}$ ). For such purpose, two programs were developed using the MATLAB programming language.

**Keywords:** Arc Furnace Modelling, MODELS, ATP Digital Simulation, Harmonics, Flicker.

## I. INTRODUCTION

Disturbances produced in electrical networks by electric arc furnaces can significantly affect the voltage quality supplied by electrical power companies.

In fact, an electric arc furnace is a non-linear, time-varying load, which gives rise to harmonics, interharmonics and voltage fluctuations (flicker). The cause of harmonics is mainly related to the non-linear voltage-current characteristic of the arc while the voltage fluctuations are due to the arc length changes that occur during the melting of the scrap.

The current and voltage harmonic distortion causes several problems in electrical power systems, such as incorrect operation of devices, premature ageing of equipment, additional losses in transmission and distribution networks, overvoltages and overcurrents.

The flicker phenomenon does not very much affect the electric equipments, but a physiological uneasiness in vision occurs due to electric lightning flux fluctuations, which are particularly important with incandescent lamps.

Therefore, it is of crucial importance to predict these effects when an arc furnace is to be connected to a network or when an existing furnace is to be upgraded. Whenever the emission limits are exceeded ([1],[2]),

mitigation techniques are to be used in order to correct such disturbances.

This paper presents guidelines for accurate prediction of the harmonics and flicker generated by arc furnaces operation. The study covers the modelling of an ac three-phase arc furnace ([3],[4],[5],[6]) using the MODELS programming language of the ATP version of the EMTP ([7],[8]), the time-domain simulation of the transmission system and the evaluation of the harmonic distortion and the flicker severity index using two external routines developed in MATLAB according to international standards ([9],[10]).

## II. ARC FURNACE MODELLING

The arc furnace modelling comprises two different features. On one hand, the accurate representation of the highly non-linear behaviour of the arc within each power cycle, which is the main cause of harmonics and interharmonics. On the other hand, the simulation of the arc length variations due to changes occurred in the melting process, are directly related to the flicker phenomenon. The model is implemented via a time-varying resistance controlled by the MODELS routine of the ATP, having the arc current as input variable.

The evaluation of the value of this resistance for each time-step is described below and follows essentially the model presented in [5], adapted to the present study.

### A. Arc furnace voltage-current characteristic

The voltage-current characteristic of the electric arc is assumed to be described by

$$V_a = V_{at}(l) + \frac{C}{D + I_a} \quad (1)$$

where  $V_a$  is the arc voltage,  $I_a$  is the arc current,  $l$  is the arc length, and  $V_{at}(l)$  is the threshold value to which voltage tends when current increases. The value of the constants  $C$  and  $D$  depends on the derivative of the

current, thus the non-reversible nature of the arc (hysteresis) being taken into account:

$$\text{for } \begin{cases} \frac{dI_a}{dt} > 0 \Rightarrow C = 190 \text{ kW and } D = 5 \text{ kA} \\ \frac{dI_a}{dt} < 0 \Rightarrow C = 39 \text{ kW and } D = 5 \text{ kA} \end{cases}$$

Figure 1 shows the voltage-current characteristic of the arc expressed by equation (1), for the given values of C and D.

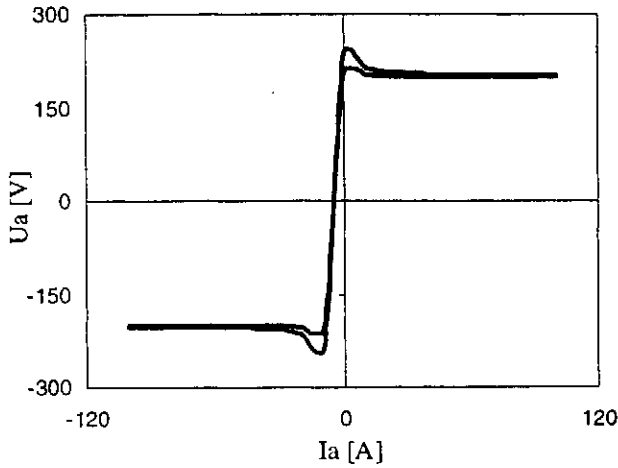

Figure 1. Arc furnace voltage-current characteristic

The introduction of the arc length variation, which is the cause of flicker, is done by the following equation:

$$V_a(I_a) = K V_{a0}(I_a) \quad (2)$$

where  $V_{a0}$  is the arc voltage correspondent to the reference length (in the present study  $l_0 = 39.5$  cm). Thus, according to equation (1), we have

$$V_{a0}(I_a) = V_{at}(l_0) + \frac{C}{D + I_a} \quad (3)$$

The threshold voltage  $V_{at}$  is given by equation (4)

$$V_{at}(l) = A + Bl \quad (4)$$

where A represents a constant that accounts for the arc anode and cathode voltage drops ( $A = 40$  V) and B is the per unit length voltage across the arc ( $B = 10$  V/cm).

The parameter K can then be evaluated by the ratio between the threshold voltage related to the actual arc length  $V_{at}(l)$  and the threshold voltage of the reference arc length  $V_{at}(l_0)$ .

$$K = \frac{V_{at}(l)}{V_{at}(l_0)} = \frac{A + Bl}{A + Bl_0} \quad (5)$$

### B. Arc length variation

The rapid changes of the arc furnace current during the different stages of the melting process are highly correlated with the arc length variation. This variation, in turn, depends on the scrap, the gases produced in the process, the electrodynamic forces and the position of the electrodes. Therefore, the accurate representation of the arc length variation is difficult to achieve. In this attempt, several authors ([5],[11],[12]) have proposed both deterministic and stochastic laws for the time-domain changes of the arc length.

The deterministic approach is based on a sinusoidal representation of the arc length variation, being the frequency chosen in the range typical of flicker (0.5 - 25 Hz). When looking for worst-case estimates, a frequency close to the maximum flicker perceptivity ( $\approx 10$ Hz) can be chosen.

However, if more realistic calculations are required, the stochastic model should be used instead. This model, although more difficult to implement, accounts for the different frequencies involved in the voltage fluctuation generated by the arc furnaces.

The time variation of the arc length is then given by

$$l(t) = l_0 - r(t) \quad (6)$$

where  $l_0$  is the reference arc length ( $l_0 = 39.5$  cm) and  $r(t)$  is band limited (5 to 20 Hz) white noise signal with an amplitude varying up to the maximum arc length deviation (30.1 cm) from the reference length (39.5 cm).

The time-varying resistance is easily obtained by dividing the evaluated arc voltage  $V_a(t)$  by the input current  $I_a(t)$

$$R(t) = \frac{V_a(t)}{I_a(t)} \quad (7)$$

This resistance is implemented in the ATP by a type 91 time-varying resistance controlled by MODELS.

Each phase is simulated separately in order to predict unbalances and to allow for an accurate harmonic evaluation.

### III. NETWORK DIGITAL SIMULATION

The arc furnace power system represented in Figure 2 is implemented in the ATP version of the EMTP.

This network represents a typical system where the Point of Common Coupling (PCC) is defined at the sending end of the transmission line (Bus 2) and the Arc Furnace terminals are represented by Bus 7.

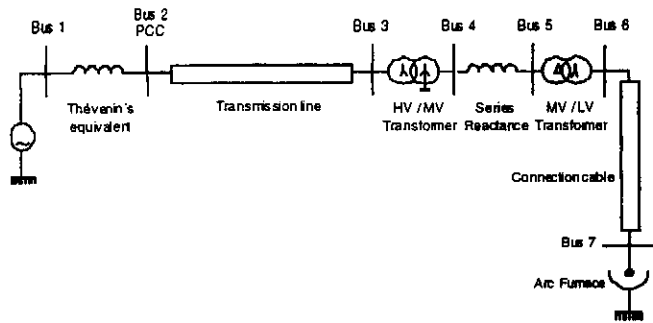

Figure 2. Electrical network supplying the arc furnace

The Thévenin equivalent represents the 220 kV, 50 Hz system connected to the transmission line. The Thévenin equivalent impedances of the considered system is given by the following positive, negative and zero sequence impedances:

$$\begin{aligned} Z_p &= 2,17978 + j 12,261 \ (\Omega) \\ Z_n &= 2,39725 + j 12,236 \ (\Omega) \\ Z_0 &= 2,03511 + j 9,1322 \ (\Omega) \end{aligned}$$

According to the aim of the simulations, and given the required timespan and timestep, two models are used for the 220 kV transmission line: for the harmonic distortion evaluation, a distributed constant parameters model is implemented while a nominal  $\Pi$  model is used for flicker simulations.

The transmission line is connected to a 220 kV/30 kV, 120 MVA, star/star transformer as represented in Figure 2. There is a series reactance of 2  $\Omega$  for flicker compensation, which is then, connected to a 30 kV/1.1 kV, 120 MVA, delta/star transformer. This transformer supplies the arc furnace through a cable represented by an  $R=0.285 \text{ m}\Omega$ ,  $X=2.85 \text{ m}\Omega$  impedance.

The arc model implemented is described in the previous section and is included in the ATP simulation by a type 91 time-varying resistance. The arc parameters are meant to simulate an 80 MW active power arc furnace.

#### IV. HARMONICS

The use of loads with non-linear voltage-current characteristics, such as the arc furnaces, result in the generation of voltage and current harmonic distortion.

In fact, arc furnaces may be the most prominent harmonic producers because of their great capacity lumped together at one place.

The simulation of the system presented in Figure 2 is carried out with a timestep of 0.15 ms to take into account harmonics up to the order 50.

Figure 3 to Figure 6 show the computed voltage and current waveforms at the Point of Common Coupling (Bus 2) and at the Arc Furnace (Bus 7).

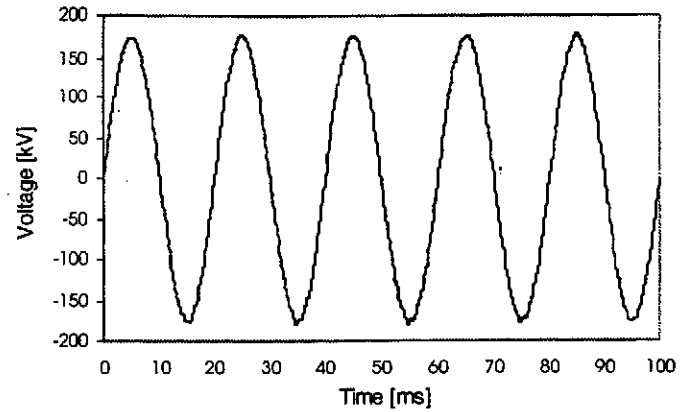

Figure 3. Voltage waveform at the PCC (Bus 2)

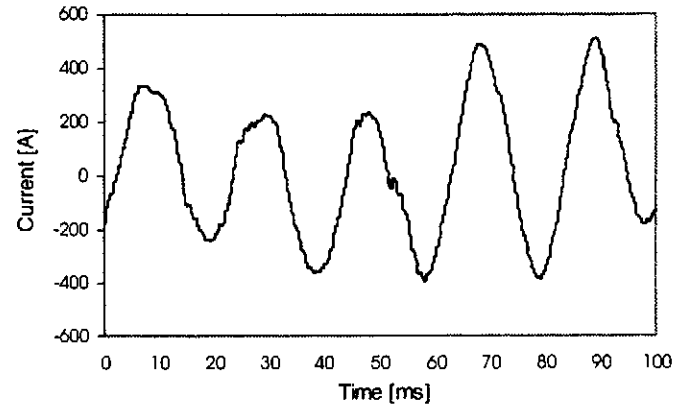

Figure 4. Current waveform at the PCC (Bus 2)

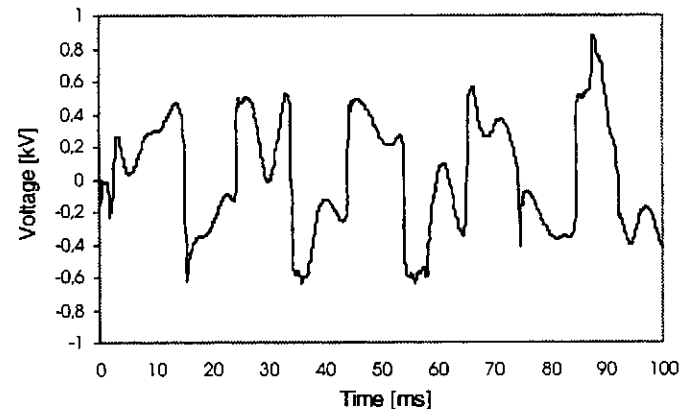

Figure 5. Voltage waveform at the Arc Furnace (Bus7)

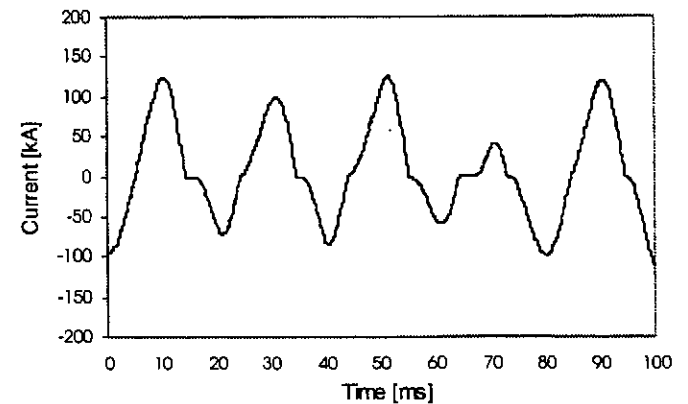

Figure 6. Current waveform at the Arc Furnace (Bus7)

It is clearly seen that the high harmonic distortion presented at the arc furnace (Bus 7) is greatly reduced by the transmission system.

Using a program developed in MATLAB, based on a Fourier analysis of the time-domain waveforms, the Total Harmonic Distortion (THD) is computed at the PCC and Arc Furnace (Table 1 and Table 2). Results are presented in percentage of the 50 Hz component.

Table 1. Voltage THD at the PCC and Arc Furnace

	THD (%) - Voltage
PCC (Bus 2)	0.25
Arc Furnace (Bus 7)	32.53

Table 2. Current THD at the PCC and arc furnace

	THD (%) - Current
PCC (Bus 2)	2.08
Arc Furnace (Bus 7)	13.26

## V. FLICKER

The flicker phenomenon is understood to refer to the sensation experienced by human vision when fast changes occur in the intensity of light sources. A persistently varying illumination can cause significant annoyance and, in consequence, may lead to complaints of affected customers.

According to extensive research work, it is known that flicker can be observed for repetitive voltage fluctuations up to a frequency where it is impossible for the eye to detect the fusion of images. This upper frequency limit can be placed approximately at 35 Hz for voltage changes less than 10 %.

Moreover, the sensitivity of human visual perception has a frequency variation and exhibits a band-pass response with maximum sensitivity between 8 and 10 Hz ([10]).

Bearing in mind that flicker mitigation techniques can be quite expensive, both for a customer with disturbing load and for the electric utility, the International Union for Electroheat (UIE) has developed an internationally agreed instrument, called the flickermeter, to measure flicker and established a criteria for the evaluation of flicker severity ([9],[10]).

In accordance to the procedure outlined in [9], a digital implementation of the UIE flickermeter was done using the MATLAB programming language. The implementation was validated using the normalised response to sinusoidal and rectangular voltage fluctuations for one unit of perceptibility presented in [10]. This program reads an input voltage with a sample frequency of 300 Hz. Therefore, when simulating the studied system,

a timestep of 1.11 ms was used. The time-domain simulations are shown in Figure 7 and Figure 8.

The program was used to predict the flicker severity associated with the voltage at PCC and at the Arc Furnace. The short-term flicker severity index ( $P_{st}$ ) associated with the voltages shown, is presented in Table 3.

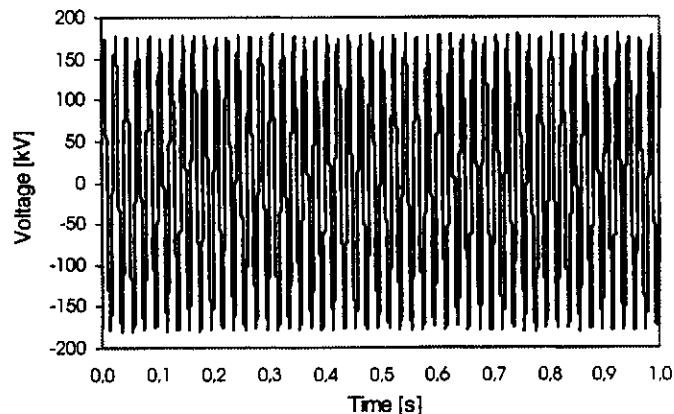

Figure 7. Voltage waveform at the PCC (Bus 2)

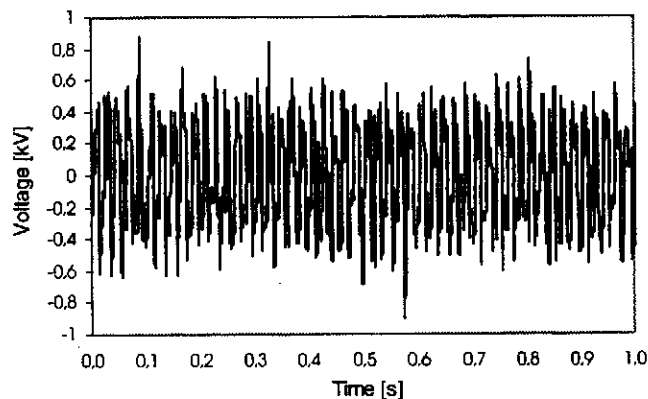

Figure 8. Voltage waveform at the Arc Furnace (Bus 7)

Table 3. Flicker severity index at the PCC and Arc Furnace

	$P_{st}$
PCC (Bus 2)	2.1
Arc Furnace (Bus 7)	4.7

## VI. CONCLUSIONS

The procedure presented in the paper allows for the accurate prediction of the harmonics and flicker generated by arc furnaces operation.

A typical case is studied in order to show the different steps of the prediction. First, a three-phase ac electric arc model is implemented using the MODELS programming language.

Then, the time-domain simulation of the electric power system to which the arc furnace is connected is accomplished.

Two developed MATLAB programs are then used to evaluate the harmonic distortion and flicker severity associated with each location at the system.

These guidelines enables the accurate prediction of the effects of the arc furnace connection and helps in the definition and design of the mitigation techniques needed to correct voltage and current distortions caused by arc furnaces operation.

## VII. REFERENCES

- [1] IEC 1000-3-6, "Electromagnetic compatibility (EMC) - Part 3: Limits - Section 6: Assessment of emission limits for distorting loads in MV and HV power systems", Basic EMC publication, 1996.
- [2] IEC 1000-3-7, "Electromagnetic compatibility (EMC) - Part 3: Limits - Section 7: Assessment of emission limits for fluctuating loads in MV and HV power systems", Basic EMC publication, 1996.
- [3] G.C. Montanari, M. Loggini, L. Pitti, E. Tironi, D. Zaninelli, "The effects of series inductors for flicker reduction in electric power systems supplying arc furnaces", *IEEE/IAS Annual Meeting*, Toronto, October 1993.
- [4] G.C. Montanari, M. Loggini, A. Cavallini, L. Pitti, D. Zaninelli, "Arc-furnace model for the study of flicker compensation in electrical networks", *IEEE Transactions on Power Delivery*, Vol. 9, No. 4, October 1994.
- [5] G.C. Montanari, M. Loggini, A. Cavallini, L. Pitti, "Flicker and distortion compensation in electrical plants supplying arc-furnaces", *IEEE*, 1994.
- [6] Cavallini, G.C. Montanari, L. Pitti, D. Zaninelli, "ATP simulation for arc-furnace flicker investigation", *ETEP*, Vol. 5, No. 3, May/June 1995.
- [7] Hermann W. Dommel, "Electromagnetic Transients Program Reference Manual", August 1986.
- [8] Leuven EMTP Center, "Alternative Transients Program Rule Book", July 1987.
- [9] IEC 868, "Flickermeter - Functional and design specifications", 1986.
- [10] UIE - Union Internationale d'Electrothermie / GDT Perturbations, "Connection of fluctuating loads", July 1988.
- [11] G. Manchur, C.C. Erven, "Development of a model for predicting flicker from electric arc furnaces", *IEEE Transactions on Power Delivery*, Vol. 7, No. 1, January 1992.
- [12] Srinivas Varadan, Elham B. Makram, Adly A. Girgis, "A new time domain voltage source model for an arc furnace using EMTP", *IEEE Transactions on Power Delivery*, Vol. 11, No. 3, July 1996.